

## INSTRUCTION MANUAL WALL CLOCK CUCKOO

KA5768, KA5964, KA5968, KA5867

**READ THIS INSTRUCTION MANUAL BEFORE USE  
AND KEEP THIS MANUAL FOR FUTURE REFERENCE.**

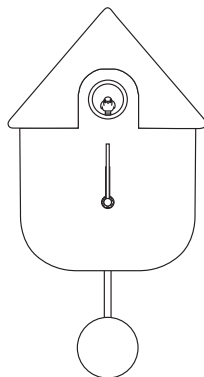

### STEPS BEFORE USE:

1 Before inserting the batteries, open the battery cover, turn the hands knob in the direction of the arrow, and set the time to 05:45 as shown below:

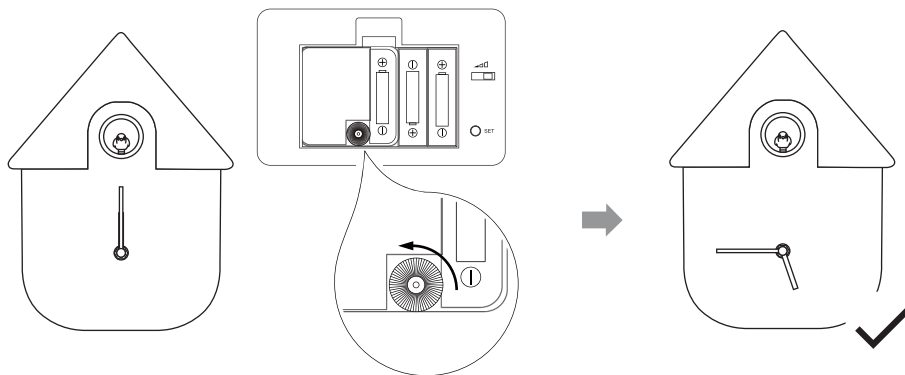

**! DO NOT TOUCH THE CLOCK HANDS TO SET TIME.**

2 Insert 3 AA batteries (not included) as illustrated.

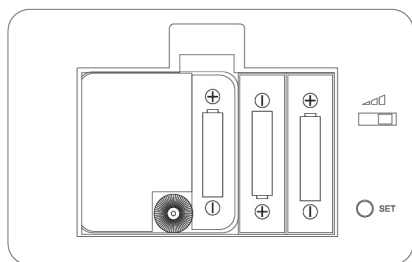

3 Continue to turn the hands knob in the direction of the arrow to set the current time.

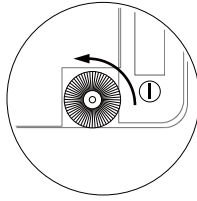
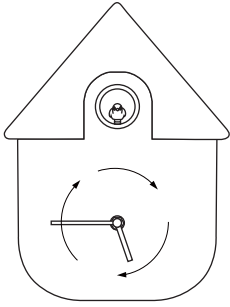

**THE TIME CAN BE SET EVEN WHEN THE BIRD IS SINGING.**

The cuckoo will stop singing from 10 p.m. (22:00) to 5 a.m. (05:00), so the current time needs to be set correctly according to 24-hour mode. For example:

Set time for 9:25 a.m.

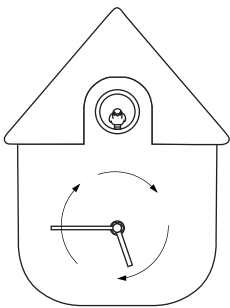

05:45

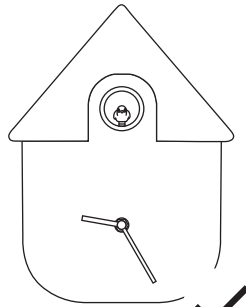
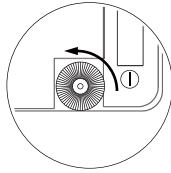

09:25

Set time for 9:25 p.m. ( 21:25 )

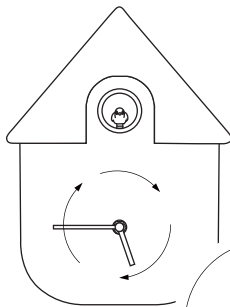

05:45

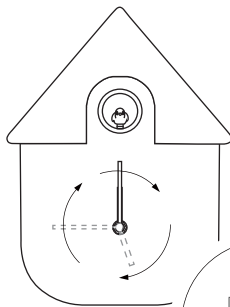
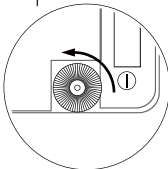

12:00

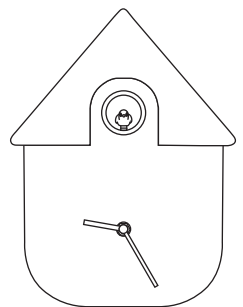
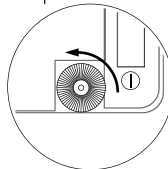

21:25

**4** Close the battery cover after the time is set correctly. Do not press “SET” button during the process. Otherwise, please take out the batteries and re-set the time by following steps (1)~(4) above.

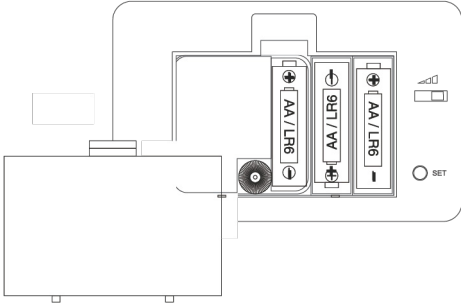

**5** Release the pendulum driver and hang the pendulum to it.

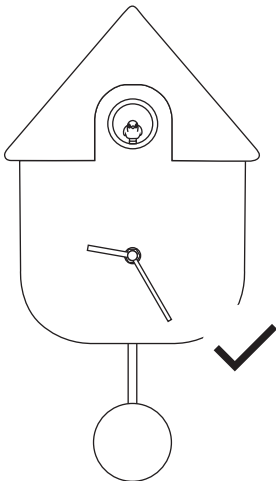
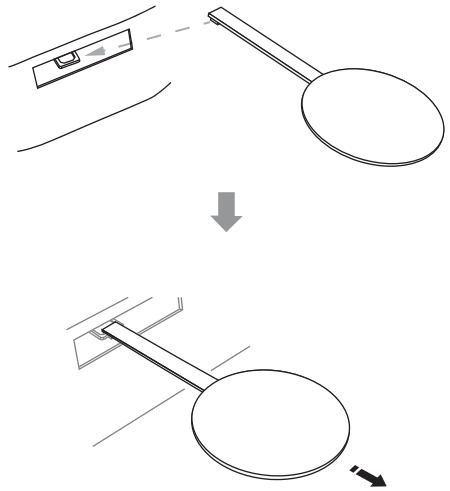
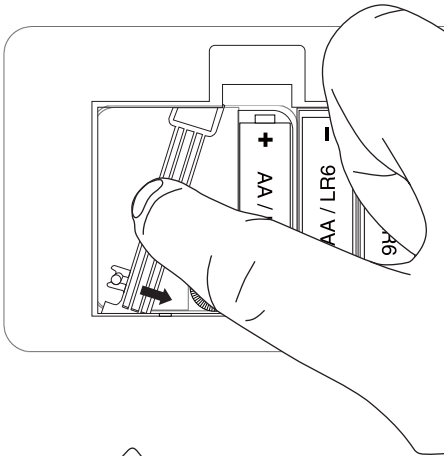

## CUCKOO SINGING FUNCTION:

The bird sound volume can be adjusted to three levels using the volume adjustment switch.

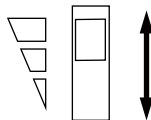

Cuckoo Silence Period: 10 p.m. (22:00) to 5 a.m. (05:00)

During this period, the cuckoo will not move or sing.

## TESTING THE CUCKOO SINGING

By pressing the “SET” button, the cuckoo will come out and sing. However, if the current time is within the silence period, the cuckoo may not come out or sing, even when the “SET” button is pressed. In this situation, please press the “SET” button multiple times until the cuckoo comes out and sings.



**AFTER PRESSING THE “SET” BUTTON, PLEASE TAKE OUT THE BATTERIES AND RE-SET THE TIME BY FOLLOWING “BEFORE USE” AT THE BEGINNING OF THE MANUAL.**

## CAUTION CHANGING BATTERIES:

To avoid battery leakage or explosion, please follow the below.

If the clock stops, either replace the batteries with new ones or remove the batteries.

Even when the clock is still working, change the batteries regularly once a year.



**WHEN CHANGING BATTERIES, PLEASE SET THE TIME BY REFERRING TO THE “BEFORE USE” AT THE BEGINNING OF THE MANUAL.**

Do not use rechargeable batteries. Use only alkaline batteries.

## TROUBLESHOOTING:

Check these points first if the product does not appear to be working properly.

PROBLEM	CAUSE & SOLUTION
The time is slow or fast.	Time accuracy is affected by temperature which may cause the time to speed up or slow down. (Usable temperature : 0 - 40 °C) If the time inaccuracy builds up, make sure to turn the hands knob in the direction of the arrow to fix the correct time. Or to change batteries.
The sound of the song slows down. Or the clock is loose time.	Please change batteries.
When the cuckoo comes out and sings, there are noises other than the cuckoo sound.	This is the sound of the cuckoo or bird moving. It is not a malfunction.
The cuckoo does not move back to the house.	The cuckoo might not move back to the house during time setting process, because the current time is in silent period. Please leave it as it is, and the cuckoo will resume to move and sing after the silent period. Or you can move back the cuckoo by pressing "SET" button. But please take out the batteries and re-set the time by following "Step for use" steps (1)-(4) above.
Cuckoo silence period is not from 10 p.m. (22:00) to 5 a.m. (05:00).	Please take out the batteries and re-set the time by following "Step for use" steps (1)-(4) above.

## HANDLEIDING WANDKLOK KOEKKOEK

KA5768, KA5964, KA5968, KA5867

**LEES DEZE HANDLEIDING VOOR GEBRUIK EN  
BEWAAR HEM VOOR TOEKOMSTIG GEBRUIK.**

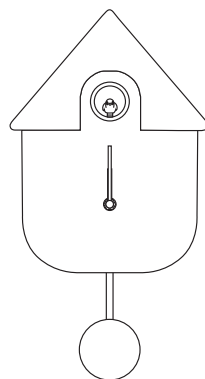

### STAPPEN VOOR GEBRUIK:

**1** Voordat u de batterijen plaatst, opent u het batterijdeksel, draait u de wijzerplaatknop in de richting van de pijl en stelt u de tijd in op 05:45 zoals hieronder aangegeven:

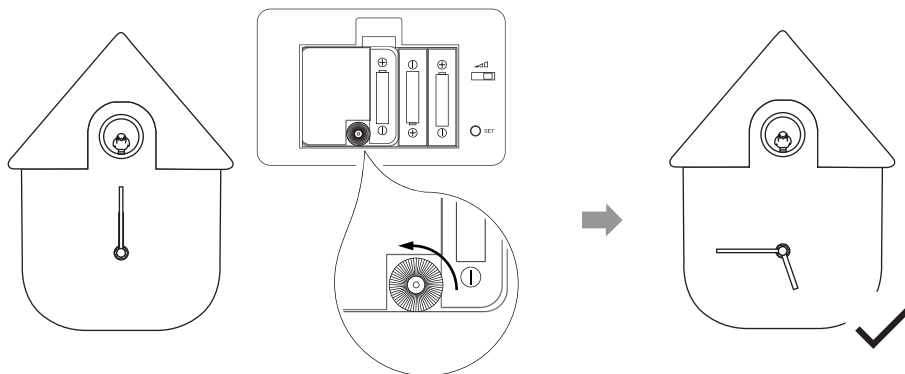

**! RAAK DE WIJZERS NIET AAN OM DE TIJD IN TE STELLEN.**

**2** Plaats 3 AA-batterijen (niet inbegrepen) zoals geïllustreerd.

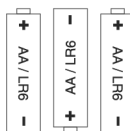
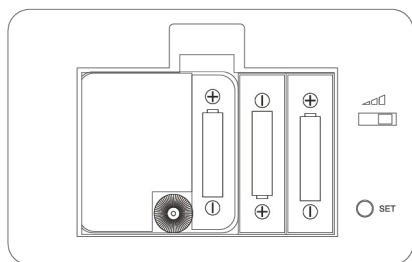

**3 Blijf de wijzers in de richting van de pijl draaien om de huidige tijd in te stellen.**

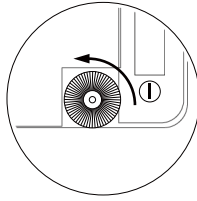
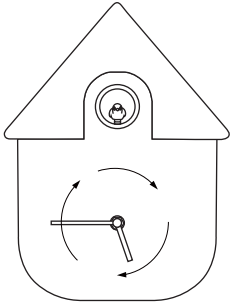

**DE TIJD KAN WORDEN INGESTELD OOK TERWIJL DE VOGEL ZINGT.**

De koekoek zal niet zingen van 22:00 uur tot 5:00 uur, dus de huidige tijd moet correct worden ingesteld volgens de 24-uursmodus. Bijvoorbeeld:

Stel de tijd in op 09:25 uur.

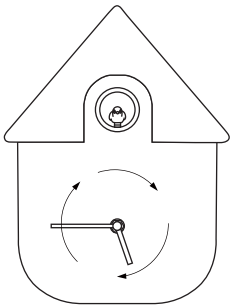

05:45

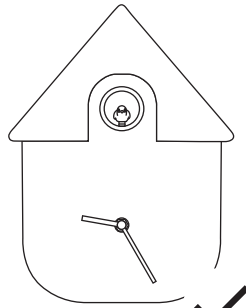
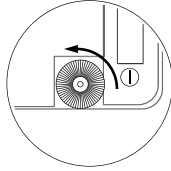

09:25

Stel de tijd in op 21:25 uur.

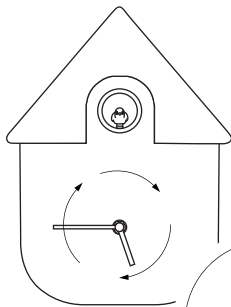

05:45

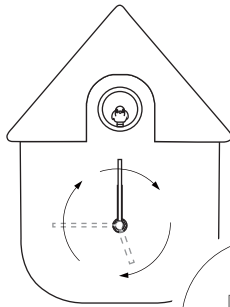
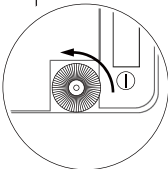

12:00

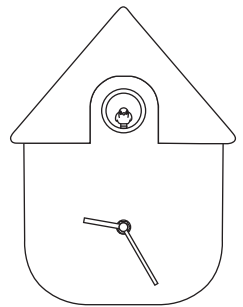
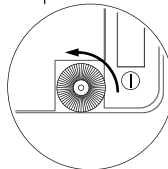

21:25

**4** Sluit de batterijafdekking wanneer de tijd correct is ingesteld. Druk tijdens het proces niet op de 'SET'-knop. Mocht er toch iets misgaan, verwijder dan de batterijen en stel de tijd opnieuw in volgens de stappen (1)~(4) hierboven.

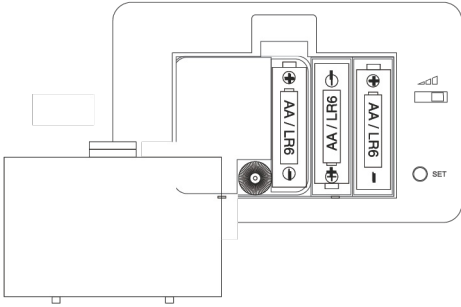

**5** Laat de slingerdrijver los en hang de slinger eraan.

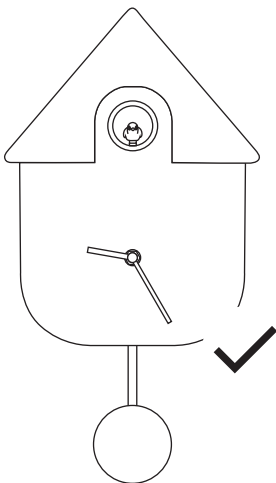
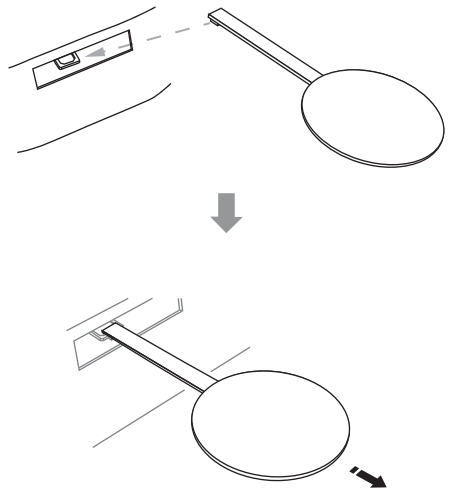
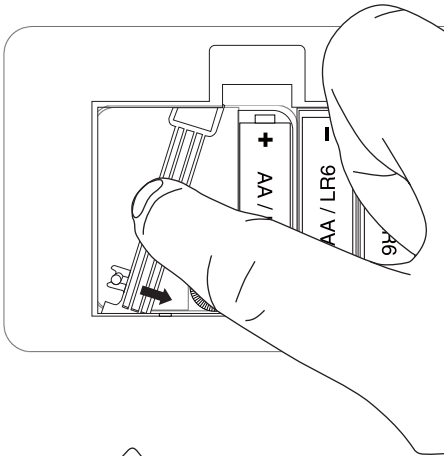



## KOEKOEKZANGFUNCTIE:

Het volume van het vogelgeluid kan op drie niveaus worden ingesteld met de volumeschakelaar.

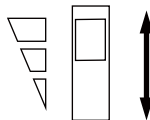

Stilteperiode Koekoek: 22:00 uur tot 05:00 uur

Tijdens deze periode zal de koekoek niet bewegen of zingen.

## TESTEN VAN DE KOEKOEKZANG

Door de 'INSTELLEN'-knop in te drukken, komt de koekoek naar buiten en zingt. Echter, als de huidige tijd binnen de stilteperiode valt, kan het zijn dat de koekoek niet naar buiten komt of zingt, zelfs als de 'INSTELLEN'-knop wordt ingedrukt. In dit geval, druk meerdere keren op de 'INSTELLEN'-knop totdat de koekoek naar buiten komt en zingt.



**NA HET INDRUKKEN VAN DE 'INSTELLEN'-KNOP, VERWIJDER DE BATTERIJEN EN STEL DE TIJD OPNIEUW IN VOLGENS 'VOOR GEBRUIK' AAN HET BEGIN VAN DE HANDLEIDING.**

## VOORZICHTIG BIJ HET VERVANGEN VAN BATTERIJEN:

Om lekkage of explosie van batterijen te voorkomen, volg de onderstaande instructies.

Als de klok stopt, vervang de batterijen door nieuwe of verwijder de batterijen.

Ook als de klok nog werkt, vervang de batterijen jaarlijks.



**BIJ HET VERVANGEN VAN BATTERIJEN, STEL DE TIJD IN DOOR TE VERWIJZEN NAAR 'VOOR GEBRUIK' AAN HET BEGIN VAN DE HANDLEIDING.**

Gebruik geen oplaadbare batterijen. Gebruik alleen alkalinebatterijen.

## PROBLEEMOPLOSSING:

Controleer deze punten eerst als het product niet naar behoren lijkt te werken.

PROBLEEM	OORZAAK & OPLOSSING
De tijd loopt langzaam of snel.	De tijdsaccuratesse kan worden beïnvloed door de temperatuur, wat ervoor kan zorgen dat de tijd sneller of langzamer gaat. (Gebruikstemperatuur: 0 - 40 °C) Als de tijd onnauwkeurig wordt, draai dan de wijzerplaatknop in de richting van de pijl om de juiste tijd in te stellen of vervang de batterijen.
Het geluid van het lied vertraagt. Of de klok loopt achter.	Vervang alstublieft de batterijen.
Wanneer de koekoek naar buiten komt en zingt, zijn er andere geluiden naast het koekoekgeluid.	Dit is het geluid van de koekoek of vogel die beweegt. Het is geen storing.
De koekoek keert niet terug naar het huis.	De koekoek keert mogelijk niet terug naar het huis tijdens het instellen van de tijd, omdat de huidige tijd in de stille periode valt. Laat het zoals het is, en de koekoek zal weer bewegen en zingen na de stille periode. Of u kunt de koekoek terugzetten door op de "SET" knop te drukken. Haal wel de batterijen eruit en stel de tijd opnieuw in volgens de stappen (1)~(4) hierboven.
De stille periode van de koekoek is niet van 22:00 tot 05:00.	Haal de batterijen eruit en stel de tijd opnieuw in volgens de stappen (1)~(4) hierboven.

## BEDIENUNGSANLEITUNG WANDUHR KUCKUCK

KA5768, KA5964, KA5968, KA5867

**LESEN SIE DIESE BEDIENUNGSANLEITUNG VOR DER BENUTZUNG UND BEWAHREN SIE SIE FÜR SPÄTERE NACHLESEN AUF.**

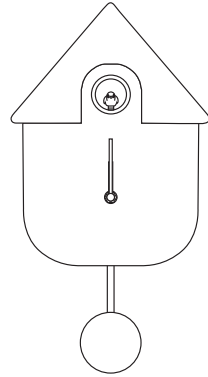

### SCHRITTE VOR DER INBETRIEBNAHME:

**1** Vor dem Einlegen der Batterien öffnen Sie die Batteriefachabdeckung, drehen Sie den Zeigerknopf in Pfeilrichtung und stellen Sie die Uhrzeit wie unten gezeigt auf 05:45 ein:

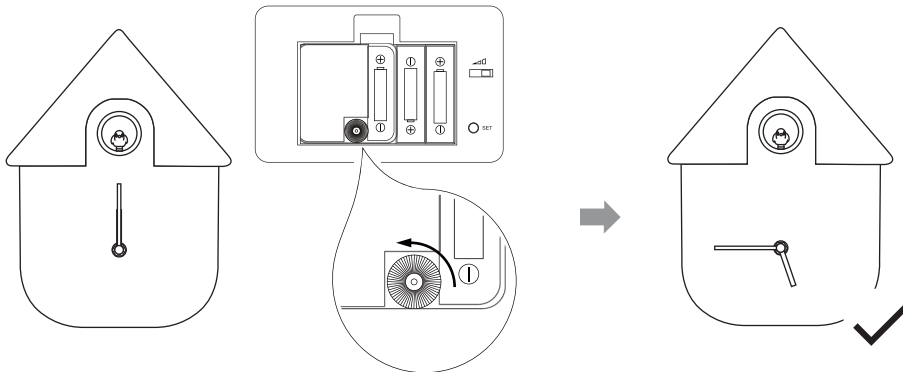

**! BERÜHREN SIE NICHT DIE ZEIGER ZUR ZEITEINSTELLUNG.**

**2** Legen Sie 3 AA-Batterien (nicht enthalten) wie abgebildet ein.

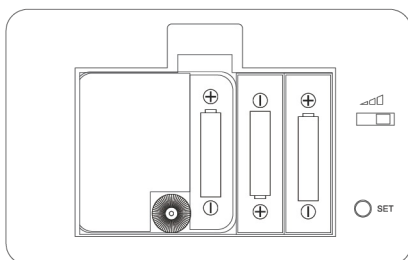

**3 Drehen Sie den Zeigerknopf weiter in Pfeilrichtung, um die aktuelle Uhrzeit einzustellen.**

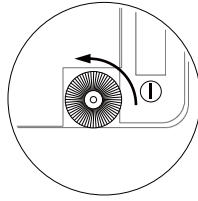
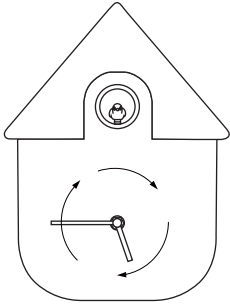

**! DIE ZEIT KANN AUCH EINGESTELLT WERDEN, WÄHREND DER VOGEL SINGT.**

Der Kuckuck hört zwischen 22:00 und 05:00 Uhr auf zu singen, daher muss die aktuelle Uhrzeit im 24-Stunden-Format korrekt eingestellt werden. Zum Beispiel: Uhrzeit auf 09:25 Uhr einstellen.

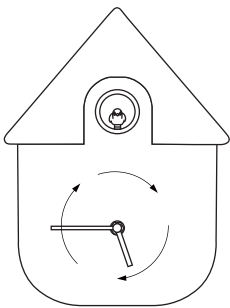

05:45

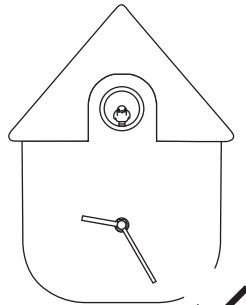
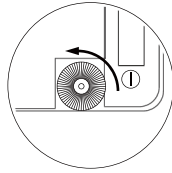

09:25

Uhrzeit auf 21:25 Uhr einstellen.

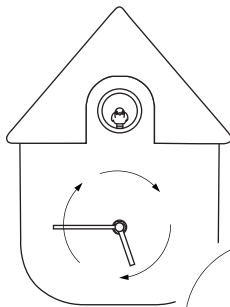

05:45

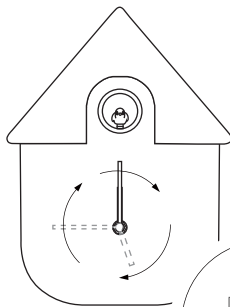
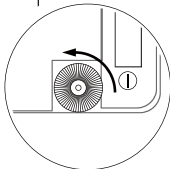

12:00

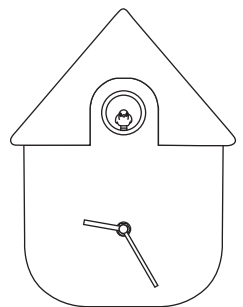
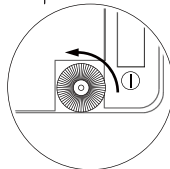

21:25

4 Schließen Sie die Batteriefachabdeckung, nachdem die Zeit korrekt eingestellt wurde. Drücken Sie während des Vorgangs nicht die „SET“-Taste. Andernfalls entnehmen Sie bitte die Batterien und stellen Sie die Zeit gemäß den obigen Schritten (1) bis (4) erneut ein.

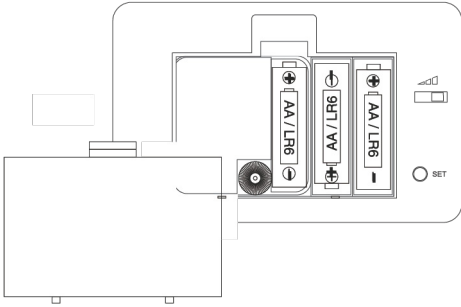

5 Lösen Sie den Pendelantrieb und hängen Sie das Pendel daran auf.

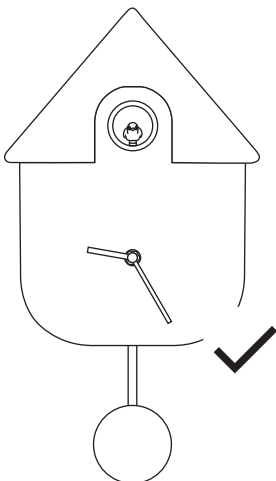
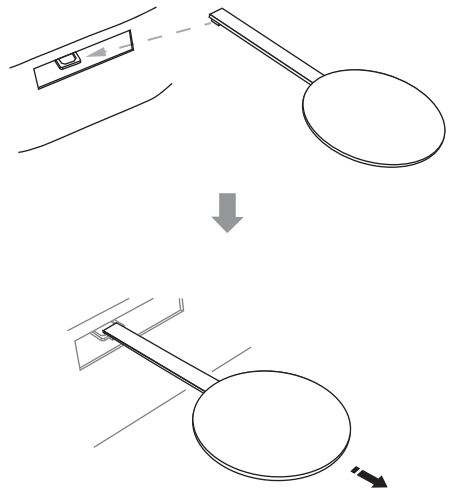
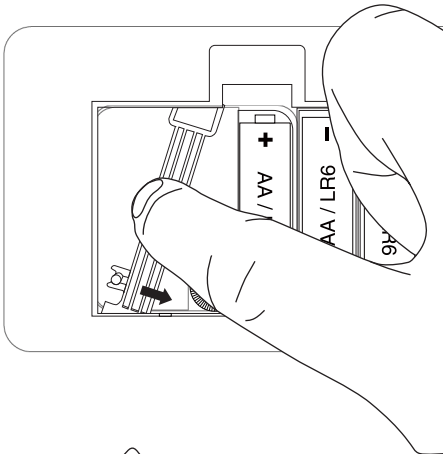

## **FUNKTION SINGENDER KUCKUCK:**

Die Lautstärke des Vogelgesangs kann mit einem Schalter auf drei Stufen eingestellt werden.

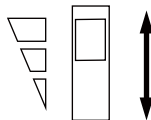

Ruhezeit des Kuckucks: 22:00 bis 05:00 Uhr

In diesem Zeitraum wird der Kuckuck weder sich bewegen noch singen.

## **TEST DES SINGENDEN KUCKUCKS**

Durch Drücken der „SET“-Taste kommt der Kuckuck heraus und singt. Sollte die aktuelle Zeit jedoch in den Ruhezeitraum fallen, kann es sein, dass der Kuckuck nicht erscheint oder singt, selbst wenn die „SET“-Taste gedrückt wird. In diesem Fall drücken Sie bitte mehrmals die „SET“-Taste, bis der Kuckuck herauskommt und singt.

 **NACH DEM DRÜCKEN DER „SET“-TASTE: BITTE DIE BATTERIEN ENTFERNEN UND DIE ZEIT ERNEUT EINSTELLEN, INDEM SIE DEM ABSCHNITT „VOR GEBRAUCH“ AM ANFANG DES HANDBUCHS FOLGEN.**

## **VORSICHT BEIM BATTERIEWECHSEL:**

Um ein Auslaufen oder Explodieren der Batterien zu vermeiden, beachten Sie bitte Folgendes. Wenn die Uhr stehen bleibt, ersetzen Sie die Batterien durch neue oder entfernen Sie die Batterien. Auch wenn die Uhr noch funktioniert, wechseln Sie die Batterien regelmäßig einmal im Jahr.

 **BEIM BATTERIEWECHSEL: BITTE DIE ZEIT EINSTELLEN, INDEM SIE SICH AUF DEN ABSCHNITT „VOR GEBRAUCH“ AM ANFANG DES HANDBUCHS BEZIEHEN.**

Verwenden Sie keine wiederaufladbaren Batterien. Nutzen Sie ausschließlich Alkalibatterien.

## FEHLERSUCHE:

Überprüfen Sie diese Punkte zuerst, wenn das Produkt nicht ordnungsgemäß funktioniert.

PROBLEM	URSACHE & LÖSUNG
Die Zeit geht zu langsam oder zu schnell.	Die Genauigkeit der Zeit wird durch die Temperatur beeinflusst, was dazu führen kann, dass die Zeit schneller oder langsamer läuft. (Nutzbare Temperatur: 0 - 40 °C) Sollte die Ungenauigkeit zunehmen, stellen Sie sicher, dass Sie den Zeigerknopf in Richtung des Pfeils drehen, um die korrekte Zeit einzustellen. Oder wechseln Sie die Batterien.
Der Klang des Liedes verlangsamt sich. Oder die Uhr verliert an Zeit.	Bitte wechseln Sie die Batterien.
Wenn der Kuckuck herauskommt und singt, gibt es zusätzliche Geräusche neben dem Kuckucksruf.	Dies ist das Geräusch des Kuckucks oder Vogels in Bewegung. Es handelt sich nicht um einen Defekt.
Der Kuckuck bewegt sich nicht zurück ins Haus.	Der Kuckuck könnte während des Einstellvorgangs nicht ins Haus zurückkehren, weil die aktuelle Zeit in der Ruheperiode liegt. Lassen Sie es einfach so, und der Kuckuck wird nach der Ruheperiode wieder in Bewegung und Gesang übergehen. Alternativ können Sie den Kuckuck durch Drücken der „SET“-Taste zurückbewegen. Nehmen Sie jedoch die Batterien heraus und stellen Sie die Zeit erneut ein, indem Sie die Schritte „Schritt zur Verwendung“ (1)-(4) befolgen.
Die Ruheperiode des Kuckucks ist nicht von 22:00 bis 05:00 Uhr.	Bitte nehmen Sie die Batterien heraus und stellen Sie die Zeit gemäß den Schritten „Schritt zur Verwendung“ (1)-(4) erneut ein.

## MANUEL D'INSTRUCTIONS HORLOGE MURALE CUCKOO

KA5768, KA5964, KA5968, KA5867

**LISEZ CE MANUEL D'INSTRUCTIONS AVANT UTILISATION ET  
CONSERVEZ-LE POUR RÉFÉRENCE FUTURE.**

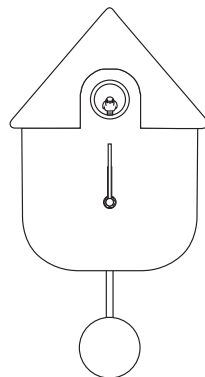

### ÉTAPES AVANT UTILISATION :

**1 Avant de placer les piles, ouvrez le couvercle des piles, tournez le bouton des aiguilles dans le sens de la flèche, et réglez l'heure à 05:45 comme illustré ci-dessous :**

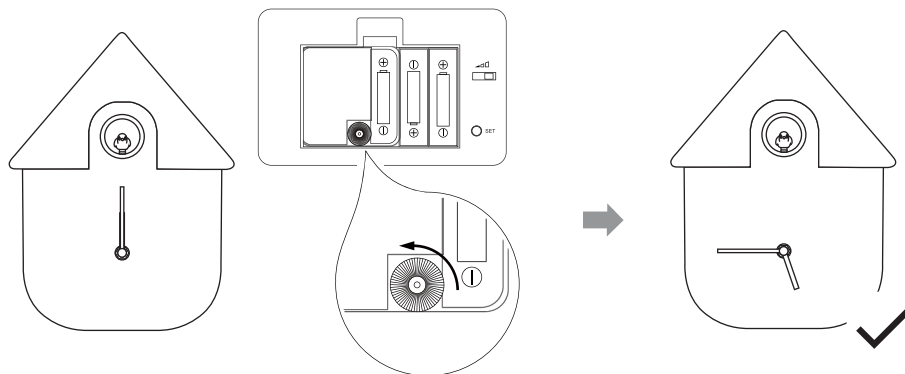

**⚠ NE TOUCHEZ PAS AUX AIGUILLES DE L'HORLOGE POUR RÉGLER L'HEURE.**

**2 Insérez 3 piles AA (non incluses) comme indiqué.**

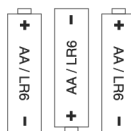
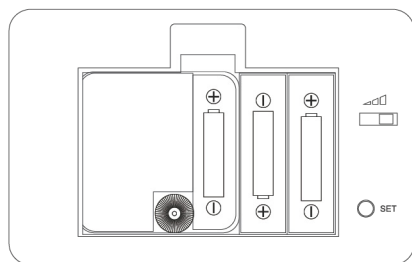



3 Continuez à tourner le bouton des aiguilles dans le sens de la flèche pour régler l'heure actuelle.

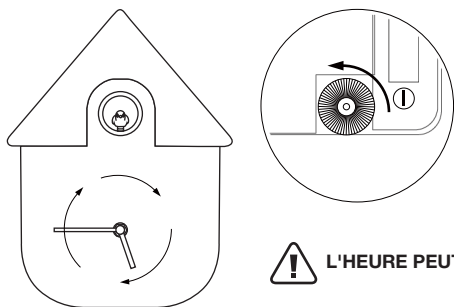

**L'HEURE PEUT ÊTRE RÉGLÉE MÊME QUAND L'OISEAU CHANTE.**

Le coucou cesse de chanter de 22h00 à 5h00, il est donc essentiel de régler correctement l'heure en mode 24 heures. Par exemple :

Réglez l'heure sur 9h25.

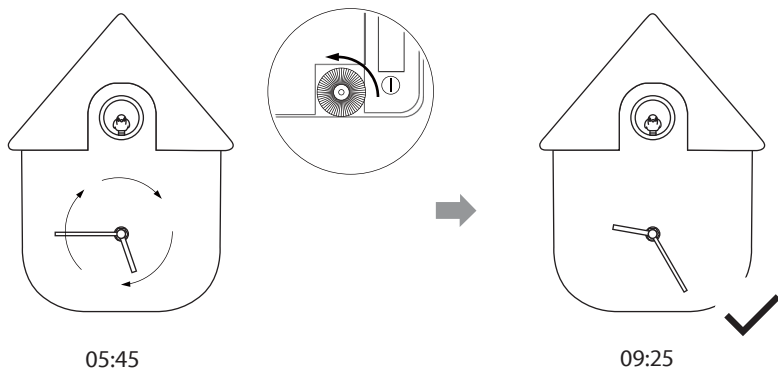

Réglez l'heure sur 21h25.

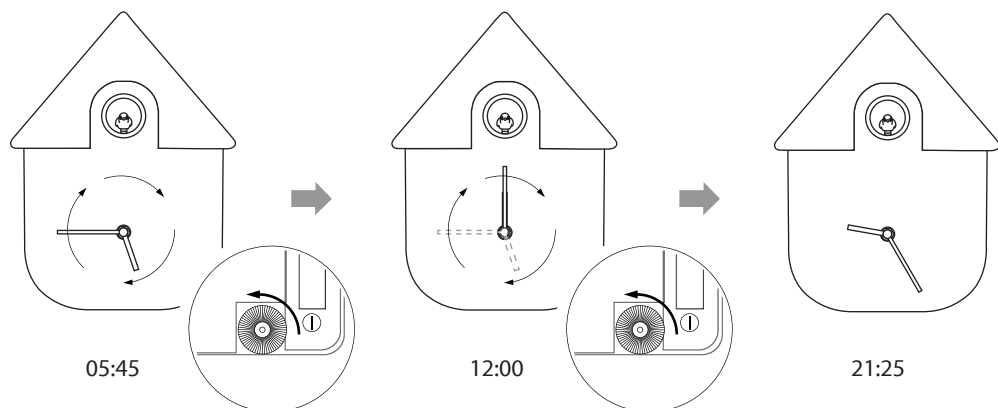

4 Fermez le couvercle de la batterie une fois l'heure correctement réglée. Ne pas appuyer sur le bouton "SET" pendant cette opération. Sinon, retirez les piles et réglez de nouveau l'heure en suivant les étapes (1) à (4) ci-dessus.

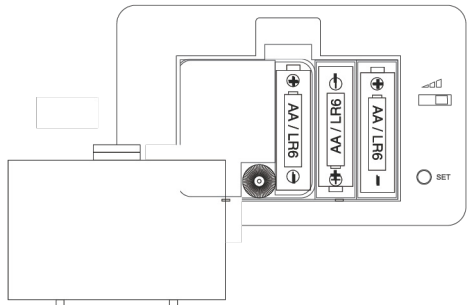

5 Libérez le mécanisme du pendule et accrochez-y le pendule.

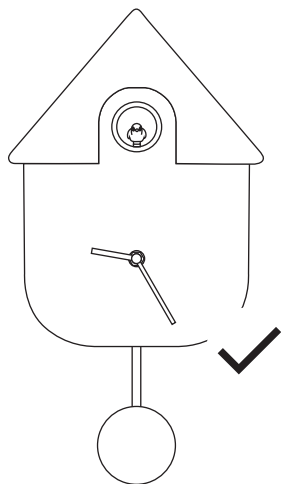
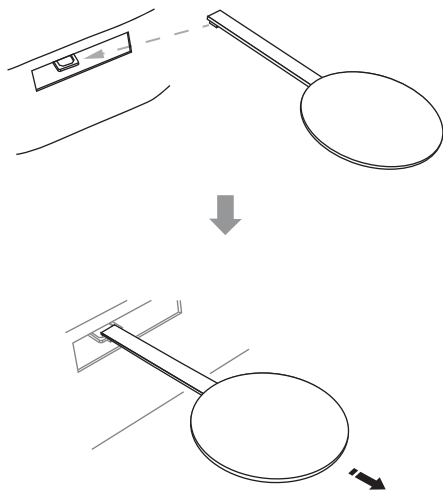
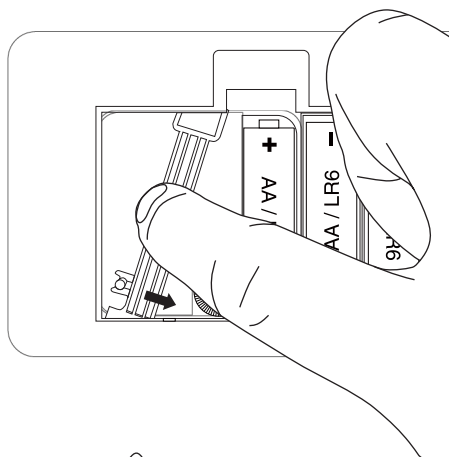

## FONCTION CHANT DU COUCOU :

Le volume du chant de l'oiseau peut être réglé sur trois niveaux à l'aide du bouton de réglage du volume.

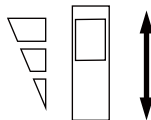

Période de silence du coucou : de 22h00 à 05h00.

Durant cette période, le coucou ne bougera pas et ne chantera pas.

## TEST DU CHANT DU COUCOU

En appuyant sur le bouton « RÉGLER », le coucou sortira et chantera. Cependant, si l'heure actuelle se situe dans la période de silence, le coucou pourrait ne pas sortir ni chanter, même si le bouton « RÉGLER » est pressé. Dans ce cas, appuyez plusieurs fois sur le bouton « RÉGLER » jusqu'à ce que le coucou sorte et chante.



**APRÈS AVOIR APPUYÉ SUR LE BOUTON « RÉGLER », RETIREZ LES PILES ET RÉGLEZ DE NOUVEAU L'HEURE EN SUIVANT LA SECTION « AVANT UTILISATION » AU DÉBUT DU MANUEL.**

## PRÉCAUTION LORS DU CHANGEMENT DES PILES :

Pour éviter toute fuite ou explosion des piles, veuillez suivre les instructions ci-dessous.

Si l'horloge s'arrête, remplacez les piles par des neuves ou retirez-les.

Même si l'horloge fonctionne toujours, changez les piles régulièrement une fois par an.



**EN CHANGEMENT DE PILES, VEUILLEZ RÉGLER L'HEURE EN VOUS RÉFÉRANT À LA SECTION « AVANT UTILISATION » AU DÉBUT DU MANUEL.**

N'utilisez pas de piles rechargeables. Utilisez uniquement des piles alcalines.

## DÉPANNAGE :

Vérifiez d'abord ces points si le produit ne semble pas fonctionner correctement.

PROBLÈME	CAUSE ET SOLUTION
L'heure avance ou retarde.	La précision de l'heure est influencée par la température, ce qui peut entraîner une avance ou un retard. (Température d'utilisation : 0 - 40 °C) Si l'imprécision persiste, assurez-vous de tourner le bouton des aiguilles dans le sens de la flèche pour régler l'heure correcte. Ou changez les piles.
Le son de la chanson ralentit. Ou l'horloge perd de l'heure.	Veuillez remplacer les piles.
Lorsque le coucou sort et chante, il y a d'autres bruits que celui du coucou.	Ce bruit est celui du coucou ou de l'oiseau en mouvement. Il ne s'agit pas d'un dysfonctionnement.
Le coucou ne retourne pas à la maison.	Le coucou pourrait ne pas retourner à la maison pendant le réglage de l'heure, car l'heure actuelle est en période de silence. Laissez-le ainsi, et le coucou reprendra ses mouvements et chants après la période de silence. Sinon, vous pouvez ramener le coucou en appuyant sur le bouton « SET ». Mais veuillez retirer les piles et réinitialiser l'heure en suivant les étapes « Étapes d'utilisation » (1)-(4) ci-dessus.
La période de silence du coucou ne s'étend pas de 22h00 à 05h00.	Veuillez retirer les piles et réinitialiser l'heure en suivant les étapes « Étapes d'utilisation » (1)-(4) ci-dessus.

## MANUALE D'ISTRUZIONI OROLOGIO DA PARETE A CUCÙ

KA5768, KA5964, KA5968, KA5867

**LEGGERE QUESTO MANUALE D'ISTRUZIONI PRIMA DELL'USO E CONSERVARLO PER FUTURE CONSULTAZIONI.**

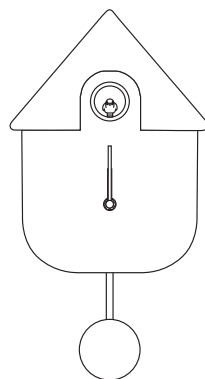

### PASSAGGI PRIMA DELL'USO:

**1** Prima di inserire le batterie, aprire il coperchio del vano batterie, ruotare il pomello delle lancette nella direzione della freccia e impostare l'orario alle 05:45 come mostrato di seguito:

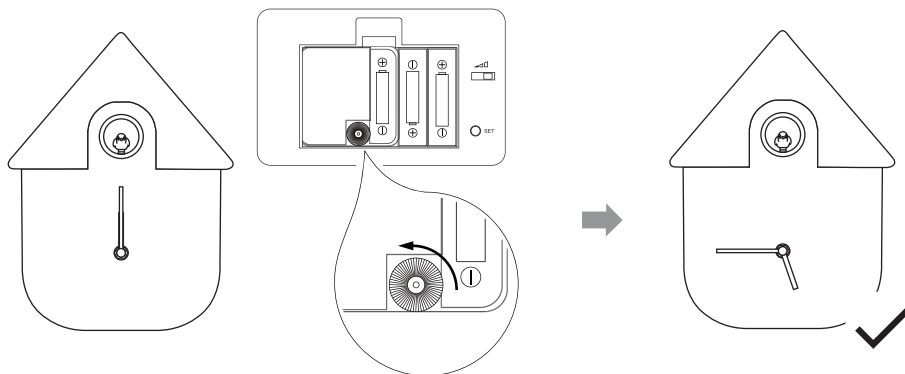

**!** NON TOCCARE LE LANCETTE PER IMPOSTARE L'ORA.

**2** Inserire 3 batterie AA (non incluse) come illustrato.

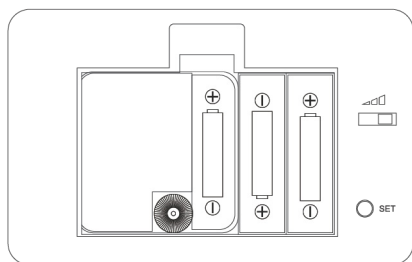

**3 Continuare a girare la manopola delle lancette nella direzione della freccia per impostare l'ora attuale.**

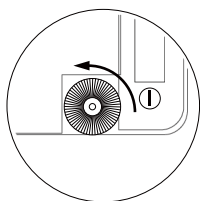
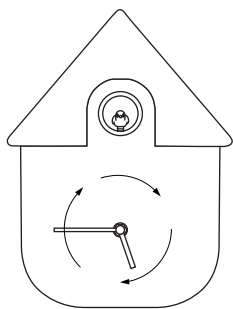

**L'ORA PUÒ ESSERE IMPOSTATA ANCHE QUANDO L'UCCELLO STA CANTANDO.**

Il cucù smetterà di cantare dalle 22:00 alle 5:00, quindi è necessario impostare correttamente l'ora attuale secondo il formato a 24 ore. Ad esempio:

Imposta l'ora alle 9:25 del mattino.

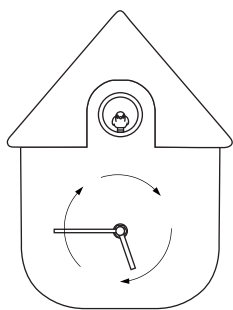

05:45

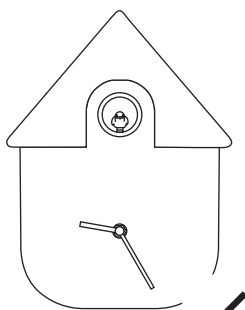
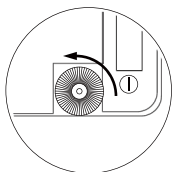

09:25

Imposta l'ora alle 21:25 di sera.

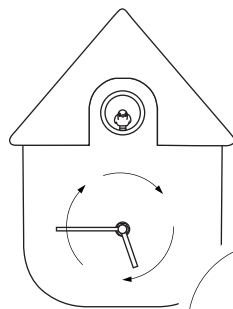

05:45

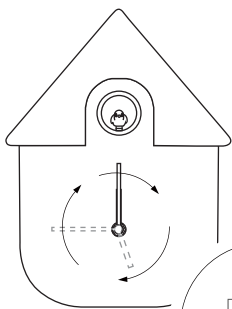
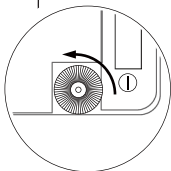

12:00

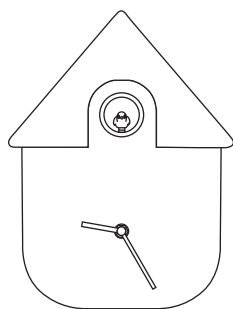
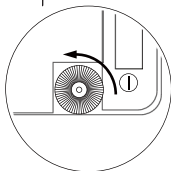

21:25

**4** Chiudere il coperchio della batteria dopo aver impostato correttamente l'orario. Non premere il pulsante 'SET' durante il processo. In caso contrario, rimuovere le batterie e reimpostare l'orario seguendo i passaggi (1)-(4) sopra indicati.

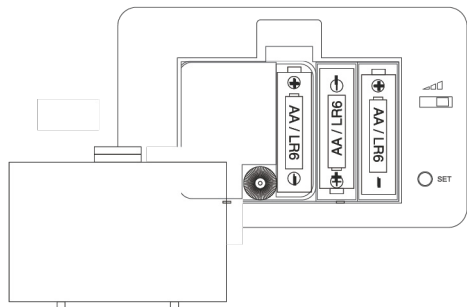

**5** Rilasciare il meccanismo del pendolo e appendere il pendolo ad esso.

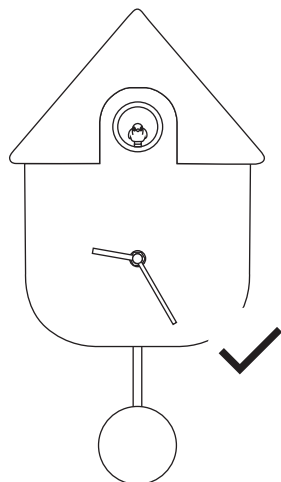
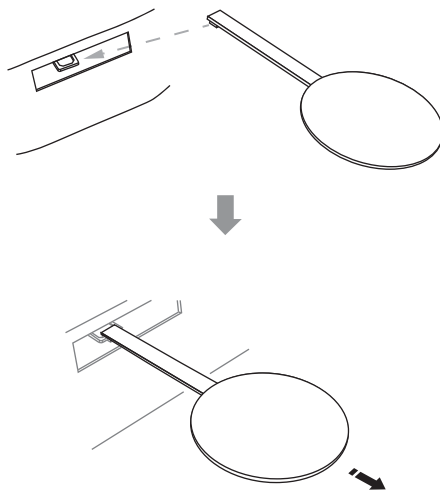
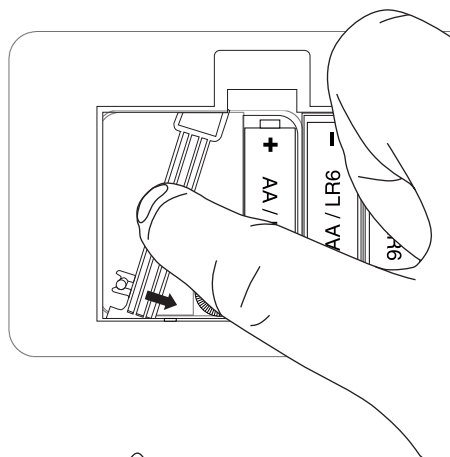

## **FUNZIONE DEL CANTO DEL CUCCÙ:**

Il volume del canto dell'uccello può essere regolato su tre livelli utilizzando l'interruttore di regolazione del volume.

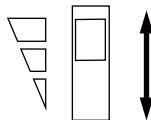

Periodo di silenzio del cuccù: dalle 22:00 alle 05:00

Durante questo periodo, il cuccù non si muoverà né canterà.

## **TEST DEL CANTO DEL CUCCÙ**

Premendo il pulsante "SET", il cuccù uscirà e canterà. Tuttavia, se l'ora corrente è nel periodo di silenzio, il cuccù potrebbe non uscire o cantare, anche se si preme il pulsante "SET". In questa situazione, premere il pulsante "SET" più volte finché il cuccù non uscirà e canterà.



**DOPO AVER PREMUTO IL PULSANTE "SET", RIMUOVERE LE BATTERIE E REIMPOSTARE L'ORA SEGUENDO LA SEZIONE "PRIMA DELL'USO" ALL'INIZIO DEL MANUALE.**

### **ATTENZIONE DURANTE IL CAMBIO DELLE BATTERIE:**

Per evitare perdite o esplosioni delle batterie, seguire le istruzioni sotto indicate.

Se l'orologio si ferma, sostituire le batterie con nuove o rimuoverle.

Anche se l'orologio funziona ancora, cambiare le batterie regolarmente una volta all'anno.



**QUANDO SI CAMBIANO LE BATTERIE, IMPOSTARE L'ORA RIFERENDOSI ALLA SEZIONE "PRIMA DELL'USO" ALL'INIZIO DEL MANUALE.**

Non utilizzare batterie ricaricabili. Usare solo batterie alcaline.



## RISOLUZIONE DEI PROBLEMI:

Verificare questi punti prima se il prodotto non sembra funzionare correttamente.

PROBLEMA	CAUSA E SOLUZIONE
L'orario è lento o veloce.	La precisione dell'orario è influenzata dalla temperatura, che può far accelerare o rallentare l'orologio. (Temperatura utilizzabile: 0 - 40 °C) Se l'inesattezza del tempo aumenta, assicurarsi di girare la manopola delle lancette nella direzione della freccia per correggere l'orario. Oppure cambiare le batterie.
Il suono della melodia rallenta. Oppure l'orologio perde tempo.	Si prega di sostituire le batterie.
Quando il cucù esce e canta, ci sono rumori oltre al suono del cucù.	Questo è il suono del cucù o dell'uccello in movimento. Non è un malfunzionamento.
Il cucù non rientra nella casetta.	Il cucù potrebbe non rientrare nella casetta durante il processo di impostazione dell'orario, poiché l'orario corrente è in periodo di silenzio. Si prega di lasciarlo così, e il cucù riprenderà a muoversi e cantare dopo il periodo di silenzio. Oppure è possibile riportare indietro il cucù premendo il tasto "SET". Tuttavia, si prega di rimuovere le batterie e reimpostare l'orario seguendo i passaggi "Passi per l'uso" (1)-(4) sopra.
Il periodo di silenzio del cucù non è dalle 22:00 alle 05:00.	Si prega di rimuovere le batterie e reimpostare l'orario seguendo i passaggi "Passi per l'uso" (1)-(4) sopra.

## MANUAL DE INSTRUCCIONES RELOJ DE PARED CUCO

KA5768, KA5964, KA5968, KA5867

**LEA ESTE MANUAL DE INSTRUCCIONES ANTES DE USAR Y  
CONSERVELO PARA FUTURAS REFERENCIAS.**

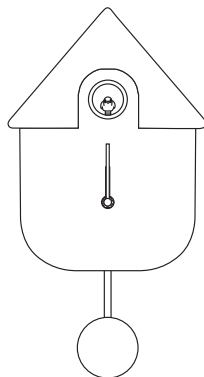

### PASOS ANTES DE USAR:

**1** Antes de insertar las pilas, abra la tapa de las pilas, gire el mando de las manecillas en la dirección de la flecha y ajuste la hora a las 05:45 como se muestra a continuación:

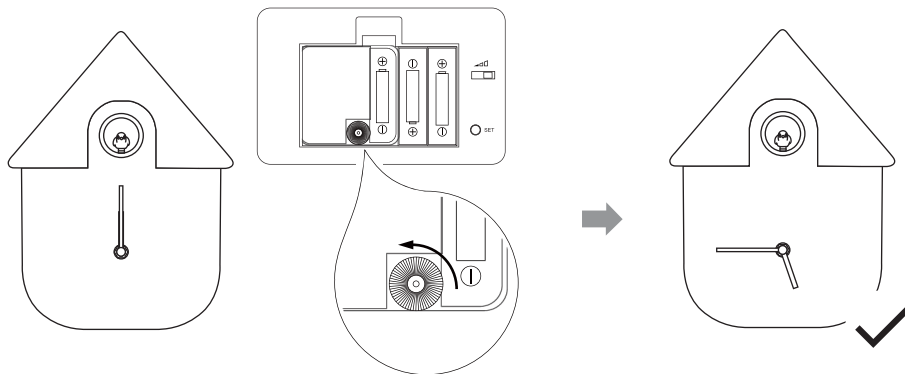

**NO TOQUE LAS MANECILLAS DEL RELOJ PARA AJUSTAR LA HORA.**

**2** Inserte 3 pilas AA (no incluidas) según se ilustra.

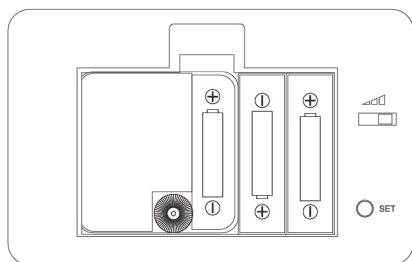

3 Continúe girando la perilla de las manecillas en la dirección de la flecha para ajustar la hora actual.

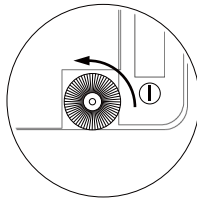
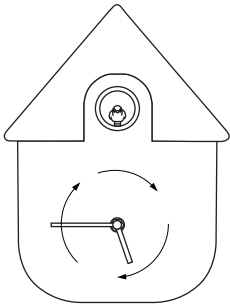

EL TIEMPO PUEDE AJUSTARSE INCLUSO CUANDO EL PÁJARO ESTÁ CANTANDO.

El cuco dejará de cantar desde las 10 p.m. (22:00) hasta las 5 a.m. (05:00), por lo que es necesario ajustar correctamente la hora actual según el modo de 24 horas. Por ejemplo:

Ajustar la hora a las 9:25 a.m.

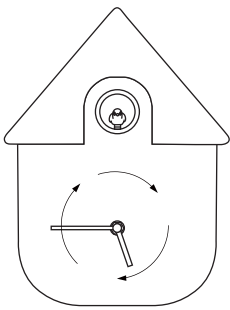

05:45

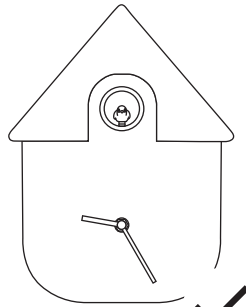
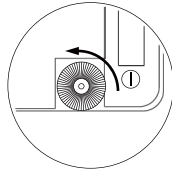

09:25

Ajustar la hora a las 9:25 p.m. (21:25)

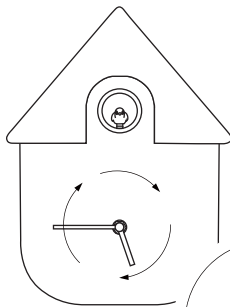

05:45

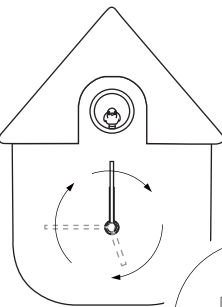
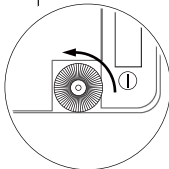

12:00

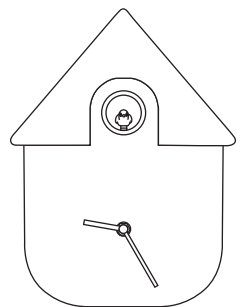
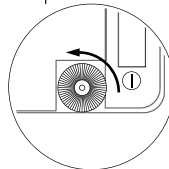

21:25

4 Cierre la tapa de la batería una vez que el tiempo esté correctamente ajustado. Por favor, no presione el botón "SET" durante el proceso. De lo contrario, retire las baterías y vuelva a ajustar el tiempo siguiendo los pasos (1)-(4) anteriormente mencionados.

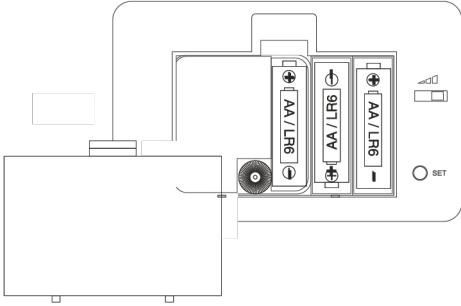

5 Libere el mecanismo del péndulo y cuelgue el péndulo en él.

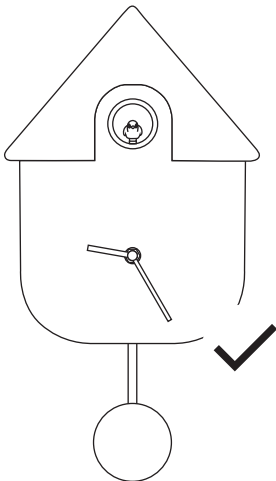
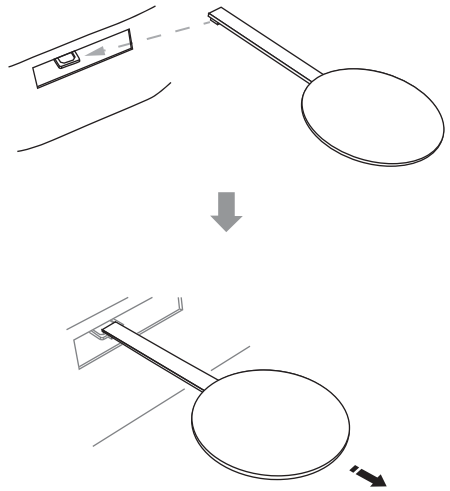
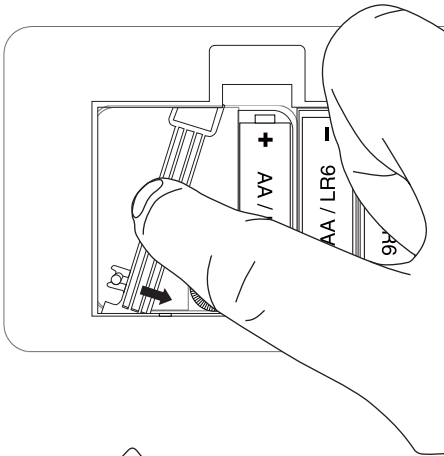

## **FUNCIÓN DEL CANTO DEL CUCO:**

El volumen del sonido del pájaro se puede ajustar a tres niveles utilizando el interruptor de ajuste de volumen.

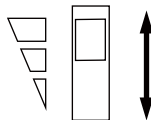

Período de Silencio del Cuco: 10 p.m. (22:00) a 5 a.m. (05:00)

Durante este período, el cuco no se moverá ni cantará.

## **PROBANDO EL CANTO DEL CUCO**

Al presionar el botón “SET”, el cuco saldrá y cantará. Sin embargo, si la hora actual está dentro del período de silencio, es posible que el cuco no salga ni cante, incluso si se presiona el botón “SET”. En esta situación, por favor presione el botón “SET” varias veces hasta que el cuco salga y cante.



**DESPUÉS DE PRESIONAR EL BOTÓN “SET”, POR FAVOR RETIRE LAS PILAS Y VUELVA A AJUSTAR LA HORA SIGUIENDO LA SECCIÓN “ANTES DE USAR” AL INICIO DEL MANUAL.**

## **PRECAUCIÓN AL CAMBIAR LAS PILAS:**

Para evitar fugas o explosiones de las pilas, por favor siga las siguientes indicaciones.

Si el reloj se detiene, reemplace las pilas con unas nuevas o retírelas.

Incluso cuando el reloj siga funcionando, cambie las pilas regularmente una vez al año.



**CUANDO CAMBIE LAS PILAS, POR FAVOR AJUSTE LA HORA REFIRIÉNDOSE A LA SECCIÓN “ANTES DE USAR” AL INICIO DEL MANUAL.**

No use pilas recargables. Utilice solo pilas alcalinas.

## RESOLUCIÓN DE PROBLEMAS:

Verifique estos puntos primero si el producto no parece funcionar correctamente.

PROBLEMA	CAUSA Y SOLUCIÓN
El tiempo es lento o rápido.	La precisión del tiempo se ve afectada por la temperatura, lo que puede causar que el tiempo se adelante o retrase. (Temperatura de uso: 0 - 40 °C) Si la inexactitud del tiempo se acumula, asegúrese de girar la perilla de las manecillas en la dirección de la flecha para corregir la hora. O cambie las pilas.
El sonido de la canción se ralentiza. O el reloj pierde tiempo.	Por favor, cambie las pilas.
Cuando el cuco sale y canta, se escuchan ruidos además del sonido del cuco.	Este es el sonido del cuco o del ave en movimiento. No es un mal funcionamiento.
El cuco no regresa a la casa.	El cuco podría no regresar a su casa durante el proceso de ajuste de tiempo, porque la hora actual está en un período de silencio. Por favor, déjelo tal como está, y el cuco reanudará su movimiento y canto después del período de silencio. O puede regresar el cuco presionando el botón "SET". Pero, por favor, retire las pilas y reajuste la hora siguiendo los pasos de "Paso para uso" (1)-(4) mencionados anteriormente.
El período de silencio del cuco no es de 10 p.m. (22:00) a 5 a.m. (05:00).	Por favor, retire las pilas y reajuste la hora siguiendo los pasos de "Paso para uso" (1)-(4) mencionados anteriormente.

## BRUGSANVISNING VÆGUR MED GØGEUR

KA5768, KA5964, KA5968, KA5867

**LÆS DENNE BRUGSANVISNING FØR BRUG OG GEM DEN TIL FREMTIDIG REFERENCE.**

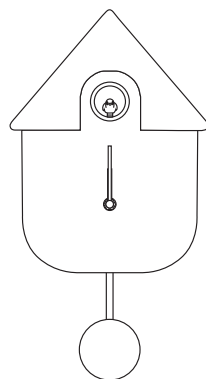

### TRIN FØR BRUG:

1 Før batterierne indsættes, åbn batteridækslet, drej visernes drejeknap i pilens retning, og indstil tiden til 05:45 som vist nedenfor:

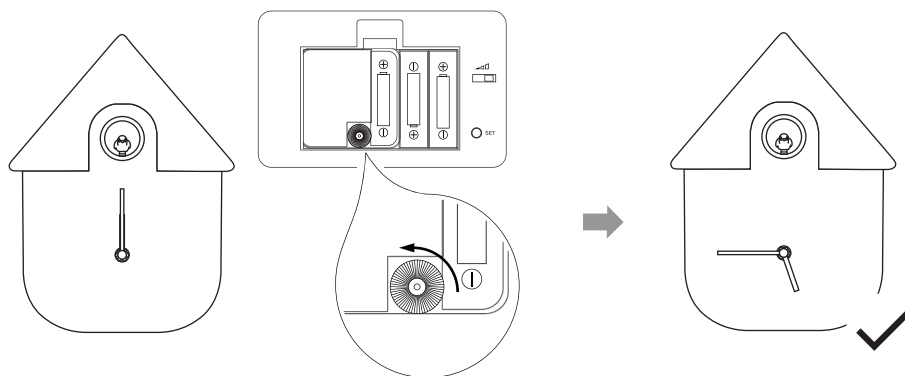

**! RØR IKKE VED URVISERNE FOR AT INDSTILLE TIDEN.**

2 Indsæt 3 AA-batterier (medfølger ikke) som vist.

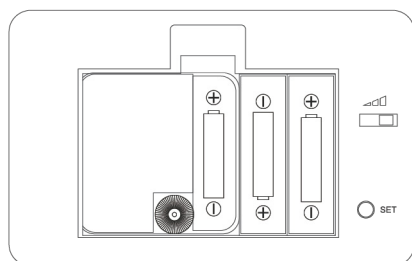

3 Drej håndtaget i pilens retning for at indstille den aktuelle tid.

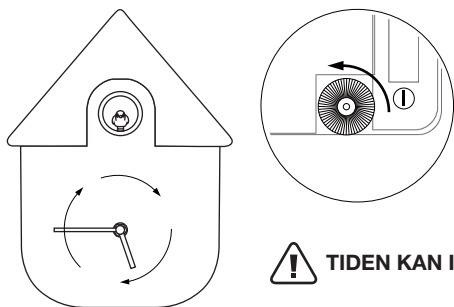

**TIDEN KAN INDSÆTTES, SELV NÅR FUGLEN SYNGER.**

Gøgen vil holde op med at synge fra kl. 22:00 til kl. 05:00, så tiden skal indstilles korrekt efter 24-timers formatet. For eksempel:

Indstil tiden til kl. 09:25.

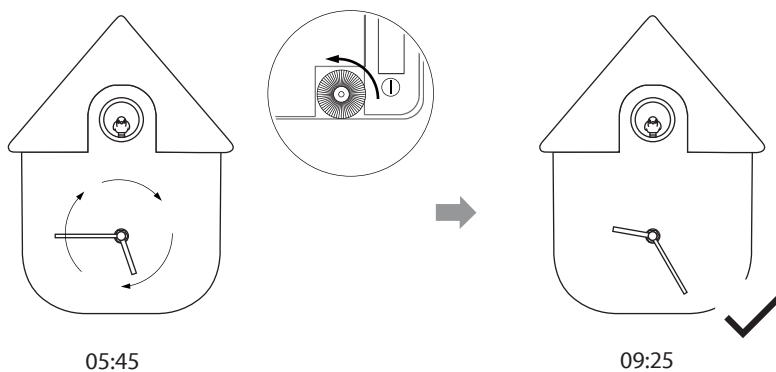

Indstil tiden til kl. 21:25.

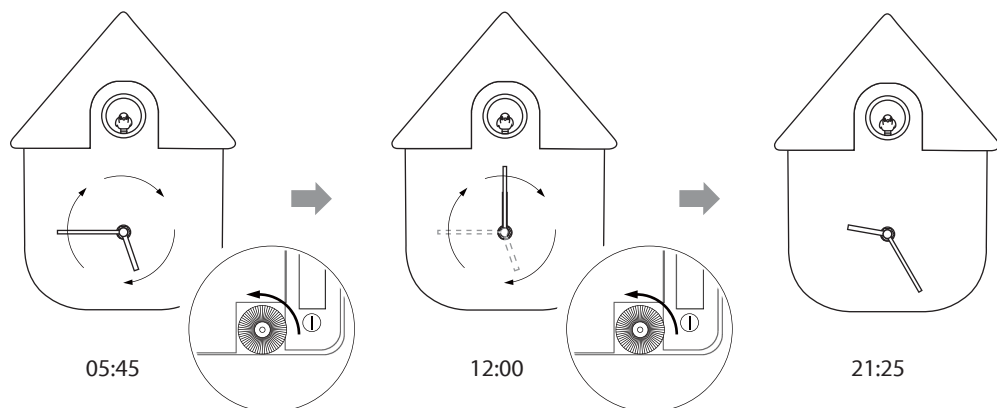



**4** Luk batteridækslet efter at have indstillet tiden korrekt. Undgå at trykke på "SET"-knappen under processen. Hvis det sker, fjern batterierne og indstil tiden igen ved at følge trin (1)~(4) ovenfor.

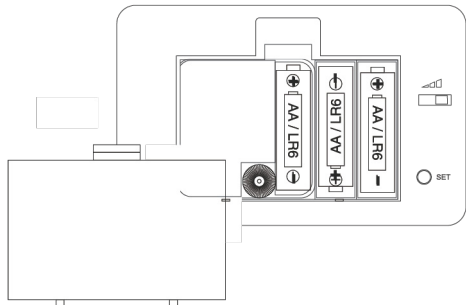

**5** Frigør penduldrivet og hæng pendulet på det.

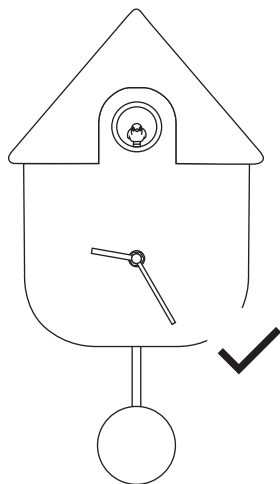
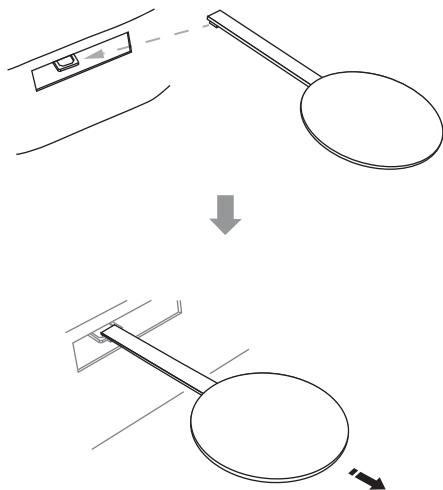
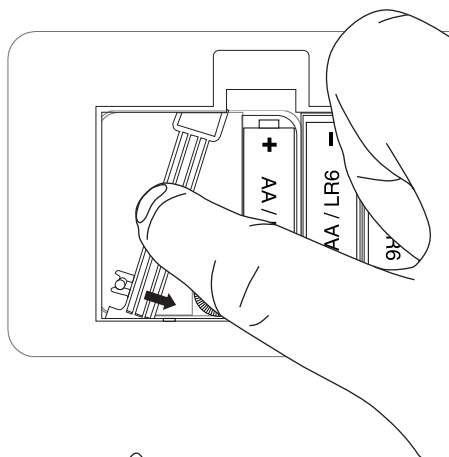

## BRUKSANVISNING VÄGUR GÖKUR

KA5768, KA5964, KA5968, KA5867

**LÄS DENNA BRUKSANVISNING INNAN ANVÄNDNING  
OCH SPARA DEN FÖR FRAMTIDA REFERENS.**

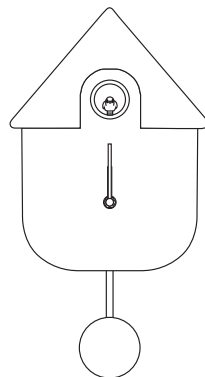

### STEG FÖRE ANVÄNDNING:

1 Innan du sätter i batterierna, öppna batteriluckan, vrid på ratt för visarna i pilens riktning och ställ in klockan på 05:45 enligt bilden nedan:

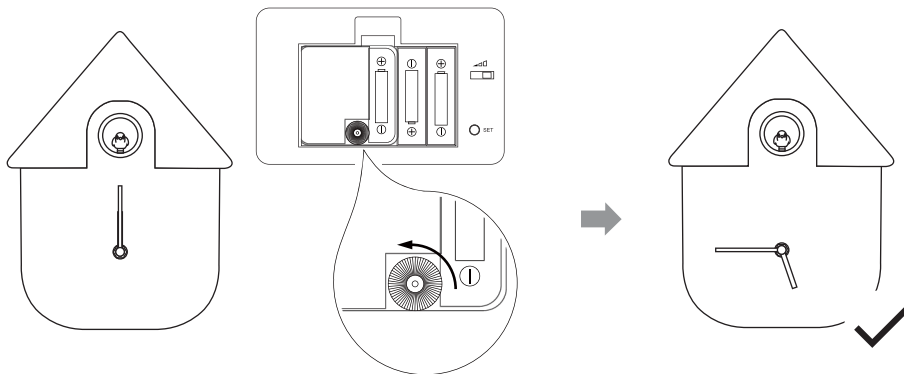

**! RÖR INTE KLOCKVISARNA FÖR ATT STÄLLA IN TIDEN.**

2 Sätt i 3 AA-batterier (ingår ej) enligt illustration.

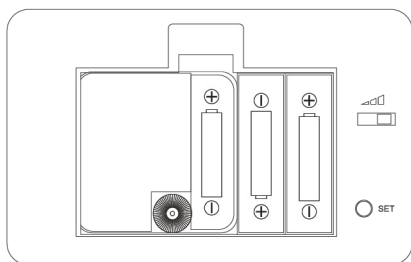

3 Fortsätt att vrida på visarknappen i pilens riktning för att ställa in aktuell tid.

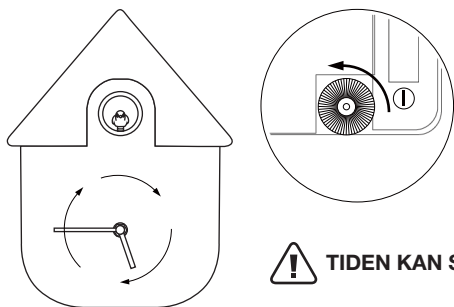

**TIDEN KAN STÄLLAS IN ÄVEN NÄR FÅGELN SJUNGER.**

Göken slutar sjunga från 22:00 till 05:00, så det är viktigt att ställa in korrekt tid enligt

24-timmarsformatet. Till exempel:

Ställ in tiden till 09:25 på morgonen.

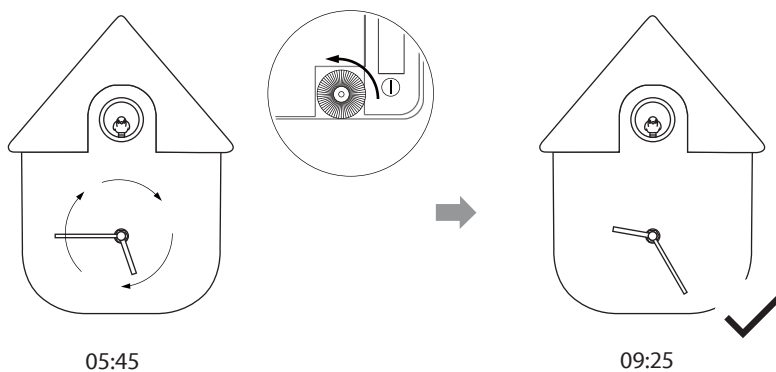

Ställ in tiden till 21:25 på kvällen.

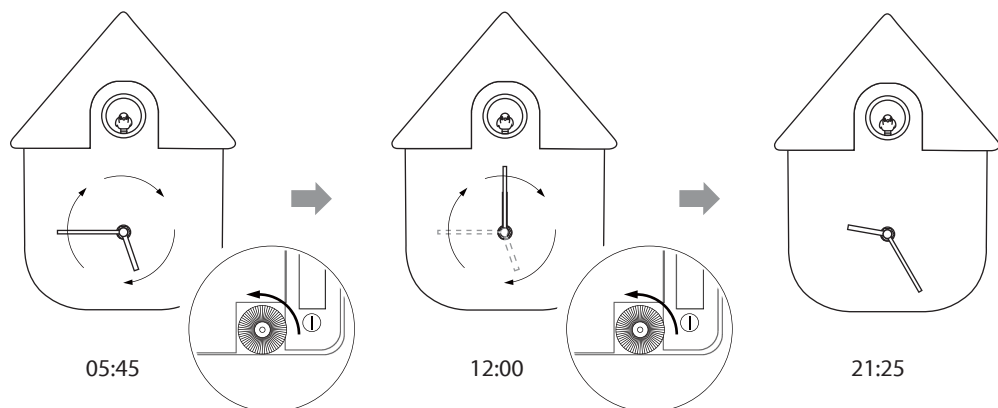

**4** Stäng batteriluckan när tiden är rätt inställd. Tryck inte på "SET"-knappen under processen. Om detta inträffar, ta ut batterierna och ställ in tiden igen genom att följa stegen (1)~(4) ovan.

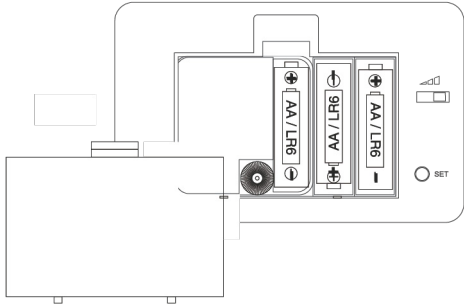

**5** Släpp pendeldrivaren och häng pendeln på plats.

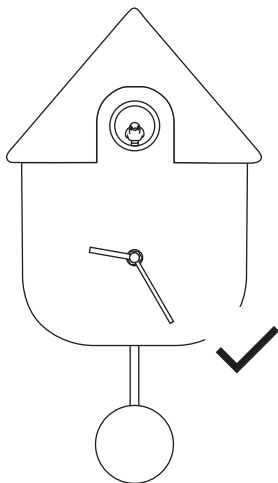
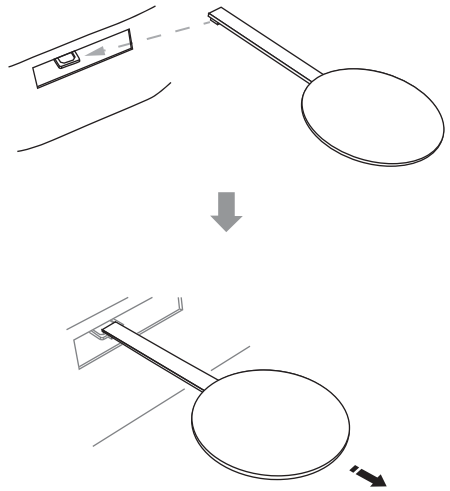
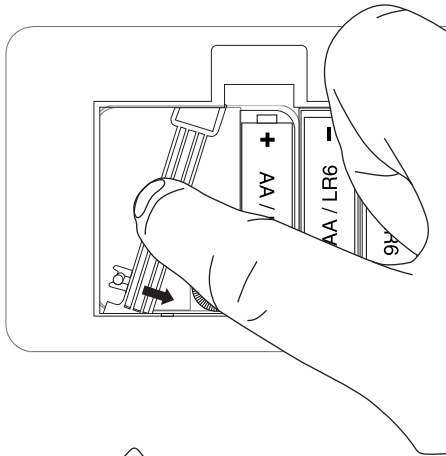

## GÖKURSSÅNGSFUNKTION:

Fågeln's ljudvolym kan justeras i tre nivåer med volyminställningsknappen.

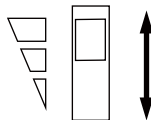

Gökens tysta period: 22:00 till 05:00

Under denna period kommer göken inte att röra sig eller sjunga.

## TESTA GÖKURSSÅNGEN

Genom att trycka på "SET"-knappen kommer göken ut och sjunger. Om tiden är inom den tysta perioden, kanske göken inte kommer ut eller sjunger även om "SET"-knappen trycks ned. I detta fall, tryck på "SET"-knappen flera gånger tills göken kommer ut och sjunger.



**EFTER ATT HA TRYCKT PÅ "SET"-KNAPPEN, TA UT BATTERIERNÄ OCH STÄLL IN TIDEN IGEN GENOM ATT FÖLJA AVSNITTET "FÖRE ANVÄNDNING" I BÖRJAN AV MANUALEN.**

## FÖRSIKTIGHET VID BYTE AV BATTERIER:

För att undvika batteriläckage eller explosion, följ nedanstående instruktioner.

Om klockan stannar, byt ut batterierna mot nya eller ta bort dem.

Även om klockan fungerar, byt batterierna regelbundet en gång per år.



**NÄR DU BYTER BATTERIER, STÄLL IN TIDEN GENOM ATT FÖLJA ANVISNINGARNA I AVSNITTET "FÖRE ANVÄNDNING" I BÖRJAN AV MANUALEN.**

Använd inte uppladdningsbara batterier. Använd endast alkaliska batterier.

## FELSÖKNING:

Kontrollera dessa punkter först om produkten inte verkar fungera korrekt.

PROBLEM	ORSAK & LÖSNING
Tiden går för långsamt eller för snabbt.	Tidsnoggrannheten påverkas av temperatur, vilket kan göra att tiden går snabbare eller långsammare. (Användbar temperatur: 0 - 40 °C) Om tidsfel uppstår, vrid visarna i pilens riktning för att ställa in rätt tid. Eller byt batterier.
Sångens ljud saktar ner. Eller så går klockan fel i tid.	Byt batterier, tack.
När göken kommer ut och sjunger, hörs andra ljud än gökens.	Detta är ljudet av göken eller fågeln som rör sig. Det är inte ett fel.
Göken går inte tillbaka till huset.	Göken kanske inte går tillbaka till huset under tidsinställningen, eftersom den aktuella tiden är under en tyst period. Låt det vara så, och göken kommer att börja röra sig och sjunga efter den tysta perioden. Eller tryck på "SET"-knappen för att flytta tillbaka göken. Men ta ut batterierna och ställ in tiden igen genom att följa "Steg för användning" (1)-(4) ovan.
Göken är inte tyst mellan 22:00 och 05:00.	Ta ut batterierna och ställ in tiden igen genom att följa "Steg för användning" (1)-(4) ovan.

## MANUAL DE INSTRUÇÕES DO RELÓGIO CUCO DE PAREDE

KA5768, KA5964, KA5968, KA5867

**LEIA ESTE MANUAL DE INSTRUÇÕES ANTES DE USAR E CONSERVE-O PARA FUTURA REFERÊNCIA.**

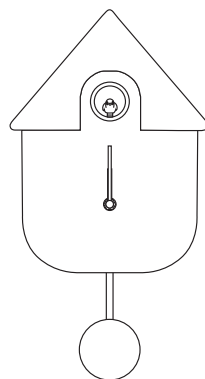

### ETAPAS ANTES DO USO:

1 Antes de inserir as pilhas, abra a tampa do compartimento, gire o botão dos ponteiros na direção indicada pela seta e ajuste o horário para 05:45 conforme mostrado abaixo:

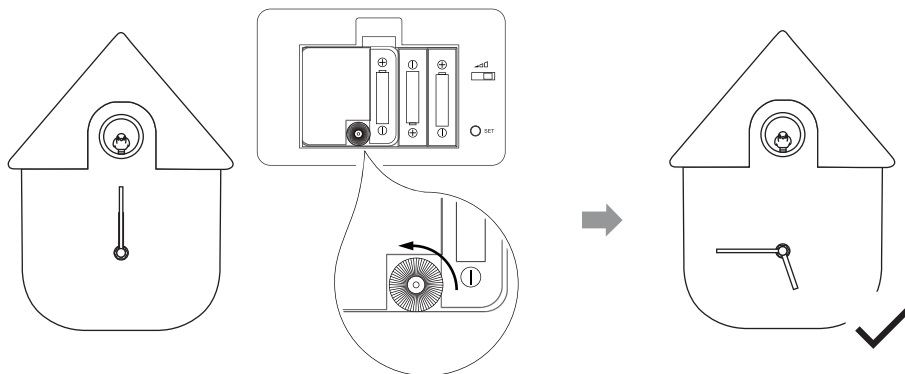

**⚠ NÃO TOQUE NOS PONTEIROS PARA AJUSTAR O HORÁRIO.**

2 Insira 3 pilhas AA (não incluídas) conforme ilustrado.

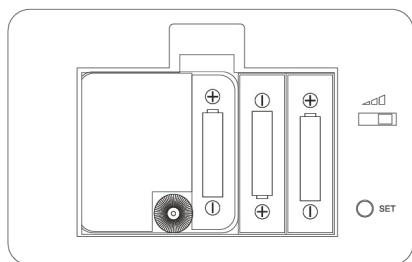

3 Continue girando o botão das mãos na direção da seta para ajustar o horário atual.

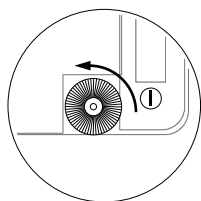
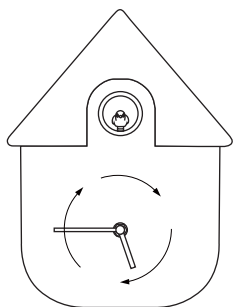

**O HORÁRIO PODE SER AJUSTADO MESMO QUANDO O PÁSSARO ESTÁ CANTANDO.**

O cuco interrompe o canto das 22:00 às 05:00, portanto, é necessário ajustar o horário corretamente no modo de 24 horas. Por exemplo:

Ajuste o horário para 09:25 da manhã.

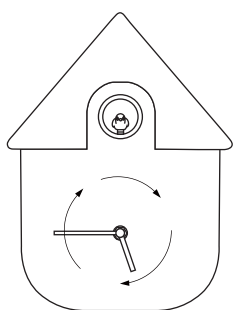

05:45

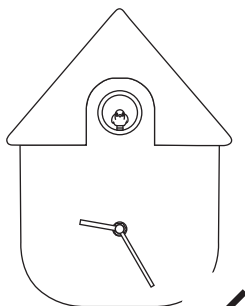
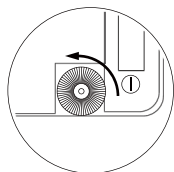

09:25

Ajuste o horário para 21:25 da noite.

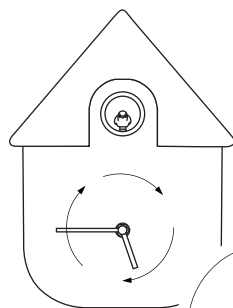

05:45

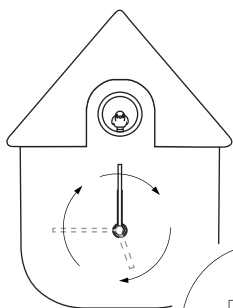
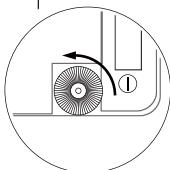

12:00

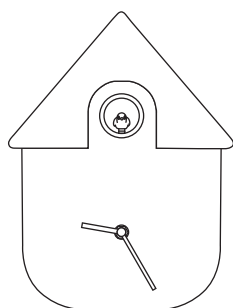
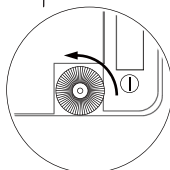

21:25



**4** Feche a tampa da bateria após ajustar corretamente a hora. Não pressione o botão “SET” durante o processo. Caso contrário, retire as baterias e ajuste novamente a hora seguindo os passos (1)~(4) acima.

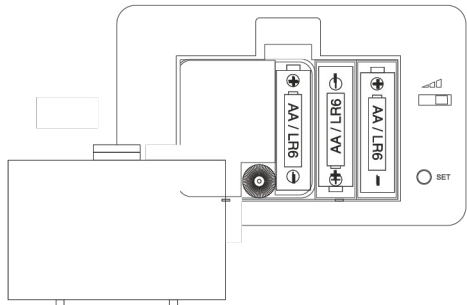

**5** Libere o mecanismo do pêndulo e pendure o pêndulo nele.

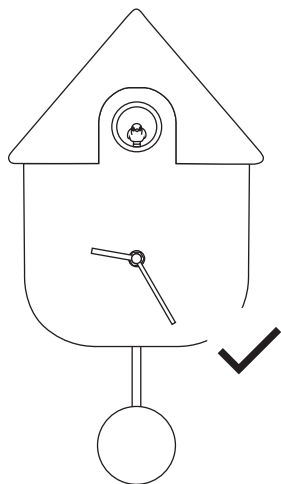
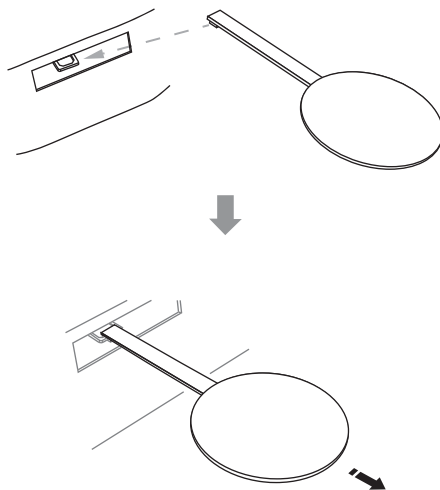
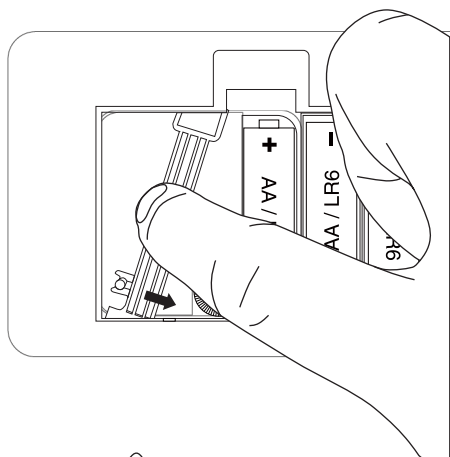

## **FUNÇÃO DO CANTO DO CUCO:**

O volume do som do pássaro pode ser ajustado em três níveis usando o interruptor de ajuste de volume.

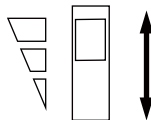

Período de Silêncio do Cuco: 22h00 às 05h00

Durante esse período, o cuco não se moverá nem cantará.

## **TESTANDO O CANTO DO CUCO**

Ao pressionar o botão “AJUSTAR”, o cuco sairá e cantará. No entanto, se o horário atual estiver dentro do período de silêncio, o cuco pode não sair ou cantar, mesmo quando o botão “AJUSTAR” for pressionado. Nesse caso, pressione o botão “AJUSTAR” várias vezes até que o cuco saia e cante.



**APÓS PRESSIONAR O BOTÃO “AJUSTAR”, RETIRE AS PILHAS E REAJUSTE O HORÁRIO SEGUINDO O “ANTES DE USAR” NO INÍCIO DO MANUAL.**

## **ATENÇÃO AO TROCAR AS PILHAS:**

Para evitar vazamento ou explosão das pilhas, siga as instruções abaixo.

Se o relógio parar, substitua as pilhas por novas ou remova as pilhas.

Mesmo que o relógio esteja funcionando, troque as pilhas regularmente uma vez por ano.



**AO TROCAR AS PILHAS, POR FAVOR, AJUSTE O HORÁRIO CONSULTANDO O “ANTES DE USAR” NO INÍCIO DO MANUAL.**

Não use pilhas recarregáveis. Use apenas pilhas alcalinas.

## DIAGNÓSTICO:

Verifique estes pontos primeiro se o produto não parecer estar funcionando corretamente.

PROBLEMA	CAUSA E SOLUÇÃO
O horário está adiantado ou atrasado.	A precisão do tempo é afetada pela temperatura, o que pode fazer com que o tempo acelere ou atrase. (Temperatura de uso: 0 - 40 °C) Se a imprecisão do tempo aumentar, certifique-se de girar o botão dos ponteiros na direção da seta para corrigir o horário. Ou troque as pilhas.
O som da música desacelera. Ou o relógio está perdendo tempo.	Por favor, troque as pilhas.
Quando o cuco sai e canta, há outros ruídos além do som do cuco.	Este é o som do cuco ou do pássaro se movendo. Não é um defeito.
O cuco não volta para a casinha.	O cuco pode não voltar para a casinha durante o processo de ajuste do horário, pois o horário atual está em período de silêncio. Por favor, deixe como está, e o cuco voltará a se mover e cantar após o período de silêncio. Ou você pode mover o cuco de volta pressionando o botão "SET". Mas, por favor, retire as pilhas e ajuste o horário seguindo os passos "Etapa de uso" (1)-(4) acima.
O período de silêncio do cuco não é das 22:00 (10 p.m.) às 05:00 (5 a.m.).	Por favor, retire as pilhas e ajuste o horário seguindo os passos "Etapa de uso" (1)-(4) acima.











## Warranty

- EN** There is a two-year warranty against manufacture defects on all Karlsson clocks, valid from the date of purchase.
- NL** Er is een garantie van twee jaar op fabricagefouten op alle Karlsson-klokken, geldig vanaf de aankoopdatum.
- DE** Auf alle Karlsson-Uhren gibt es eine zweijährige Garantie auf Herstellungsfehler, die ab dem Kaufdatum gültig ist.
- FR** Il y a une garantie de deux ans contre les défauts de fabrication sur toutes les horloges Karlsson, valable à partir de la date d'achat.
- IT** Tutti gli orologi Karlsson sono coperti da una garanzia di due anni contro i difetti di fabbricazione, valida dalla data di acquisto.
- ES** Existe una garantía de dos años contra defectos de fabricación en todos los relojes Karlsson, válida a partir de la fecha de compra.
- DK** Der er to års garanti mod fabriktionsfej på alle Karlsson-ure, der gælder fra købsdatoen.
- PL** Na wszystkie zegary Karlsson udzielana jest dwuletnia gwarancja na wady fabryczne, ważna od daty zakupu.
- PT** Há uma garantia de dois anos contra defeitos de fabricação em todos os relógios Karlsson, válida a partir da data de compra.
- SE** Det finns två års garanti mot fabriktionsfel på alla Karlssons klockor, gäller från inköpsdatum.

## Maintenance

- EN** A soft cloth may be used to clean your clock. Do not use corrosive cleaner or chemical solution on the clock.
- NL** Een zachte doek kan worden gebruikt om uw klok schoon te maken. Gebruik geen bijtende reiniger of chemische oplossing op de klok.
- DE** Ein weiches Tuch kann verwendet werden, um Ihre Uhr zu reinigen. Verwenden Sie kein ätzendes Reinigungsmittel oder eine chemische Lösung für die Uhr.
- FR** Un chiffon doux peut être utilisé pour nettoyer votre horloge. N'utilisez pas de nettoyeur corrosif ou de solution chimique sur l'horloge.
- IT** È possibile utilizzare un panno morbido per pulire l'orologio. Non utilizzare detergenti corrosivi o soluzioni chimiche sull'orologio.
- ES** Se puede usar un paño suave para limpiar el reloj. No use limpiadores corrosivos o solución química en el reloj.
- DK** En blød klud kan bruges til at rengøre dit ur. Brug ikke ætsende rengøringsmiddel eller kemisk opløsning på uret.
- PL** Do czyszczenia zegara można użyć miękkiej szmatki. Nie używaj środków czyszczących ani roztworów chemicznych na zegarze.
- PT** Um pano macio pode ser usado para limpar seu relógio. Não use produtos de limpeza corrosivos ou solução química no relógio.
- SE** En mjuk trasa kan användas för att rengöra din klocka. Använd inte frätande rengöringsmedel eller kemisk lösning på klockan.

## WEEE Symbol

-  **EN** The crossed-out wheeled bin symbol indicates that the item should be disposed of separately from household waste. The item should be handed in for recycling in accordance with local environmental regulations for waste disposal.
-  **ES** La imagen del cubo de basura tachado indica que el producto no debe formar parte de los residuos habituales del hogar. Se debe reciclar según la normativa local medioambiental de eliminación de residuos.
-  **NL** Het symbool met de doorgestreepte vuilnisbak op wiertjes geeft aan dat het product gescheiden van het huishoudelijk afval moet worden aangeboden. Het product moet worden ingeleverd voor recycling in overeenstemming met de plaatselijke milieuvorschriften voor afvalverwerking.
-  **PL** Przekreślony symbol kosza na odpady oznacza, że oznaczony produkt nie może być wyrzucany wraz ze zmieszanyimi odpadami komunalnymi z gospodarstwa domowego. Zużyty sprzęt elektryczny i elektroniczny należy przekazać do przetwarzania i recyklingu zgodnie z obowiązującymi w danym kraju przepisami ochrony środowiska dotyczącymi gospodarowania odpadami.
-  **DE** Das Symbol mit der durchgestrichenen Abfalltonne bedeutet, dass das Produkt getrennt vom Haushaltsabfall entsorgt werden muss. Das Produkt muss gem. der örtlichen Entsorgungsvorschriften der Wiederverwertung zugeführt werden.
-  **PT** O símbolo do caixote do lixo com o sinal de proibição indica que esse artigo deve ser separado dos resíduos domésticos convencionais. Deve ser entregue para reciclagem de acordo com as regulamentações ambientais locais para tratamento de resíduos.
-  **FR** Le pictogramme de la poubelle barrée indique que le produit doit faire l'objet d'un tri. Il doit être recyclé conformément à la réglementation environnementale locale en matière de déchets.
-  **DK** Táknið með mynd af ruslatunnu með krossi yfir þýðir að ekki má farga vörinni með venjulegu heimilissorpi. Vörinni þarf að skila í endurvinnslu eins og lög gera ráð fyrir á hverjum stað fyrir sig.
-  **IT** Il simbolo del cassonetto barrato indica che il prodotto non può essere eliminato con i comuni rifiuti domestici. Il prodotto dev'essere riciclato nel rispetto delle norme ambientali locali per lo smaltimento dei rifiuti.
-  **SE** Symbolen med den överkorsade soptunnan betyder att produkten ska kasseras separat från hushållsavfall. Produkten ska lämnas in för återvinning enligt lokala regler för avfallshantering.